

Sicaan.

HERA

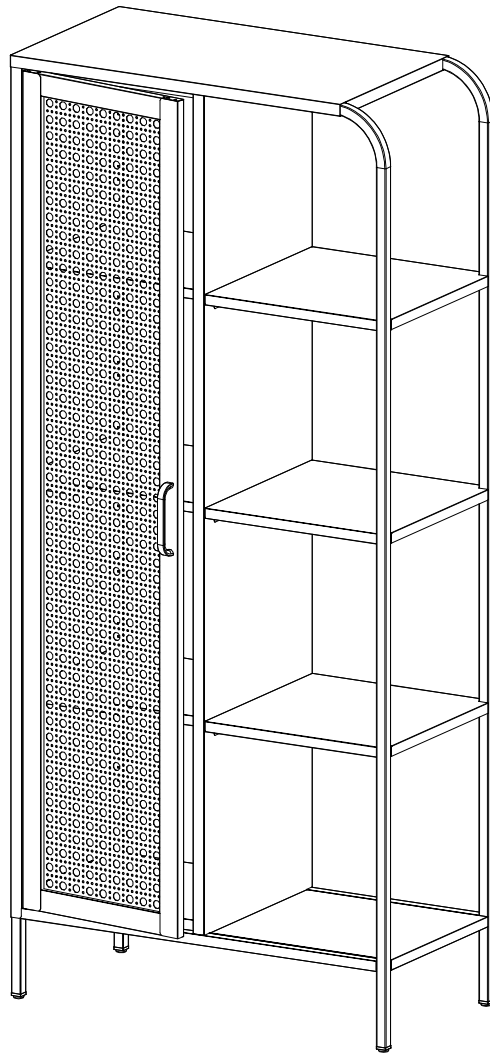

45 min



x2









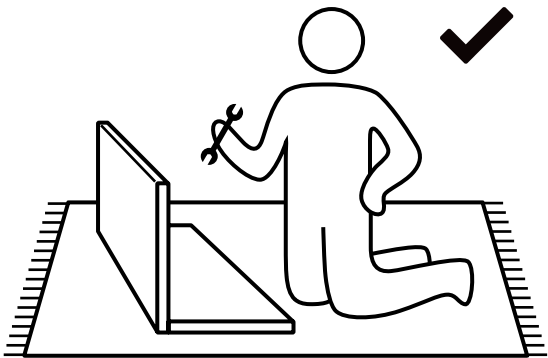
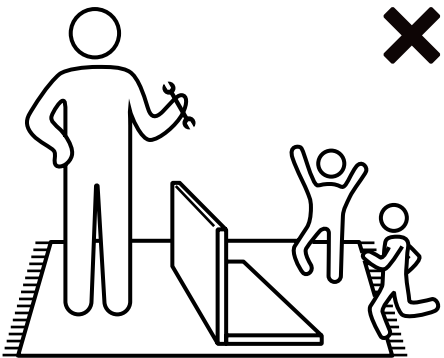
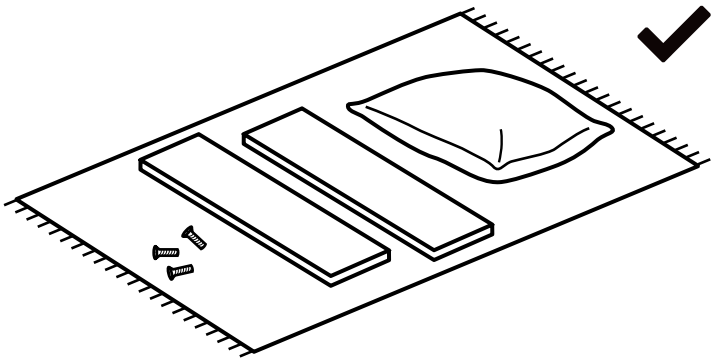
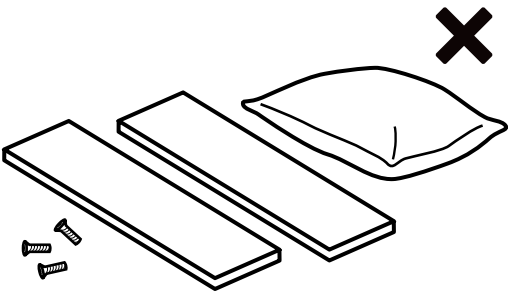
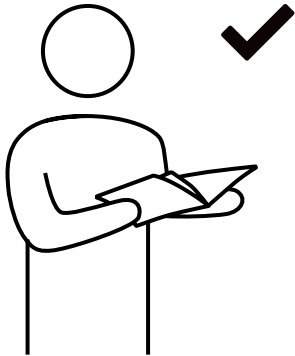
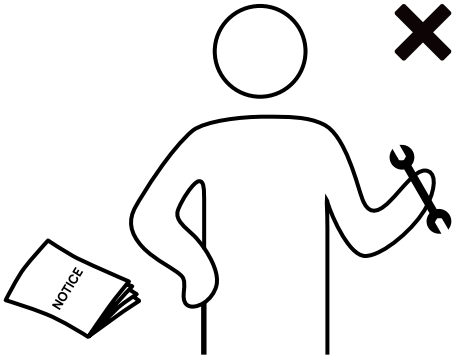

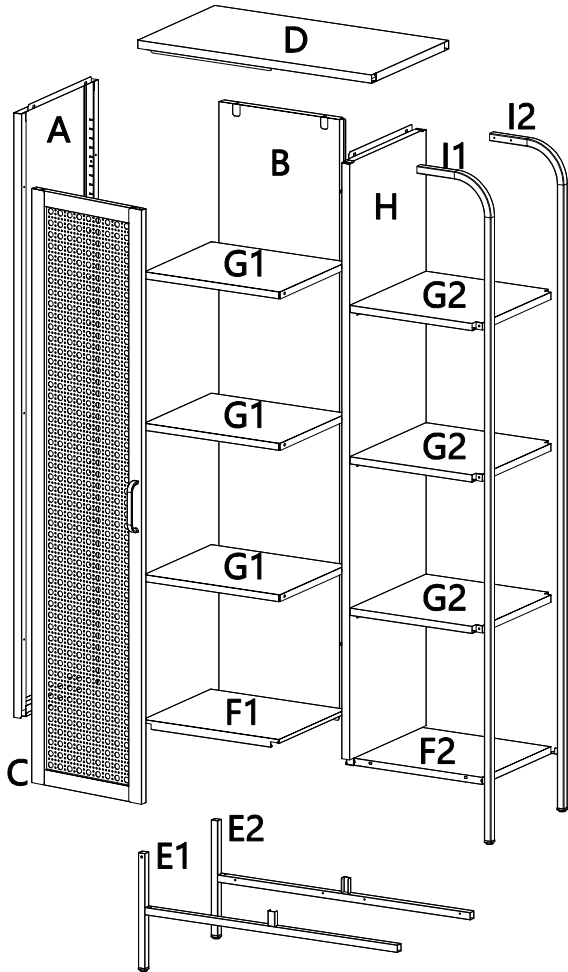
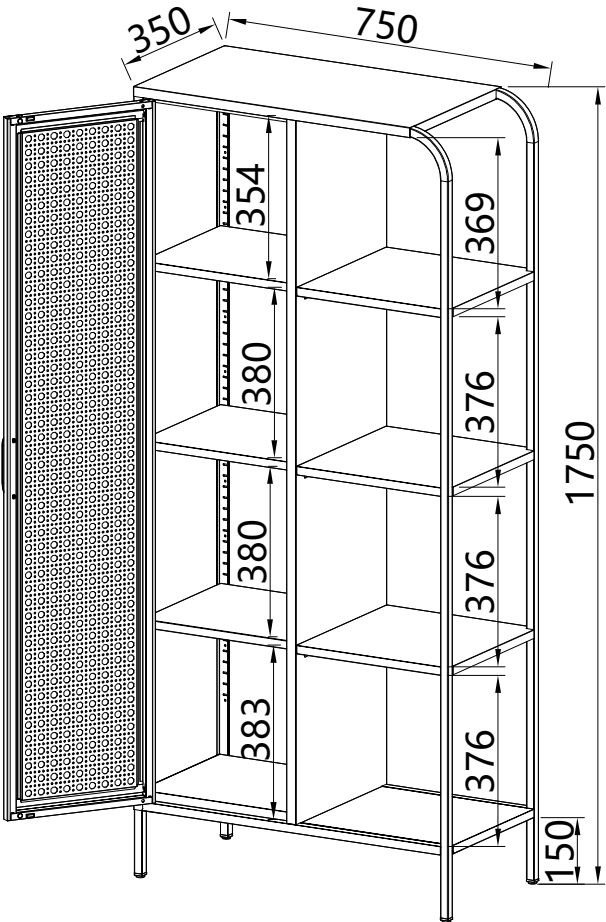
CE

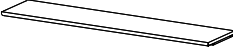
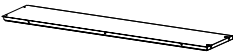



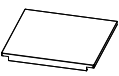
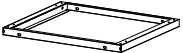



04/2026

COM-001831 COM-001832



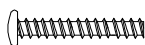
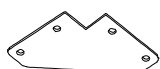

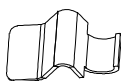

	REF	PCS	QTY	DIM
	A	PCS-005871	x1	158.1 x 35 x 2.4 cm
	B	PCS-005876	x1	157.1 x 33.8 x 2.3 cm
	C	PCS-005877	x1	155.3 x 33.5 x 2 cm
	D	PCS-005878	x1	65.4 x 35.2 x 2.3 cm
	E1	PCS-005879	x1	72.9 x 32 x 2 cm
	E2	PCS-005880	x1	72.9 x 32 x 2 cm
	F1	PCS-005881	x1	38.3 x 30.1 x 2.5 cm
	F2	PCS-005882	x1	36.2 x 30.7 x 2 cm
	G1	PCS-005883	x3	38.3 x 30 x 2 cm
	G2	PCS-005872	x3	36.3 x 34.7 x 2 cm
	H	PCS-005873	x1	158.1 x 35 x 2.4 cm

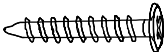
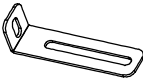
	REF	PCS	QTY	DIM
	11	PCS-005874	x1	175 x 20 x 2 cm
	12	PCS-005875	x1	175 x 20 x 2 cm
	1	PCS-005000	x38	Ø 5 x 12 mm
	2	PCS-005011	x1	Ø 6 x 30 mm
	3	PCS-005017	x3	Ø 12 x 0.8 mm
	4	PCS-005018	x2	Ø 2 x 22 mm
	5	PCS-005817	x4	62 x 62 mm
	6	PCS-005818	x1	150 x 20 x 20 mm
	7	PCS-005021	x12	30 x 13 mm
	8	PCS-005014	x6	Ø 5 x 10 mm
	9	PCS-005023	x2	9 x 19 mm

	REF	PCS	QTY	DIM
	10	PCS-005001	x 2	Ø 8 x 38 mm
	11	PCS-005002	x 2	Ø 4 x 38 mm
	12	PCS-005819	x 2	15 x 76 mm

1.

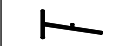
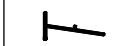
			
A	H	E1	E2

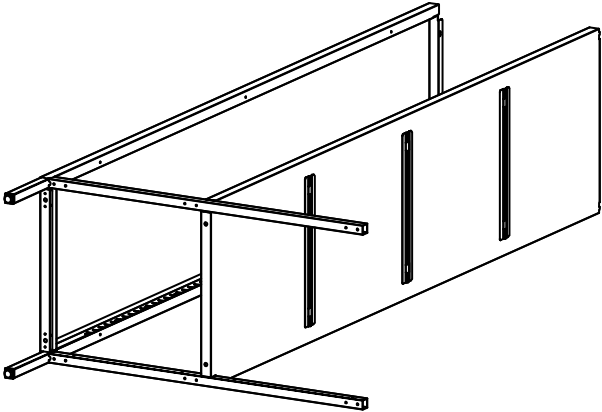
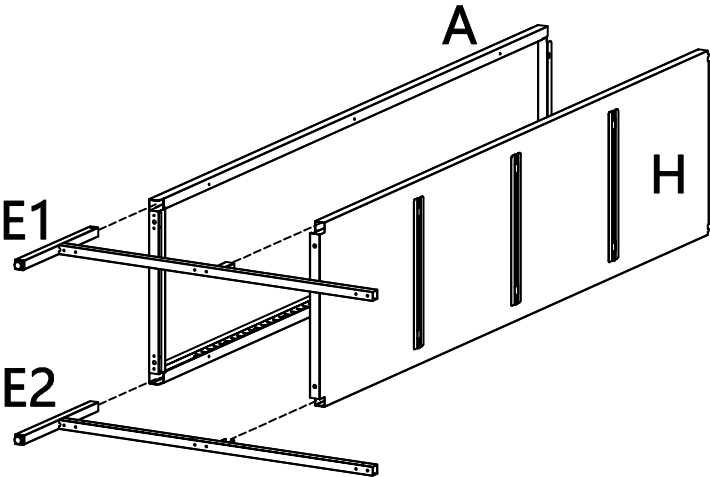

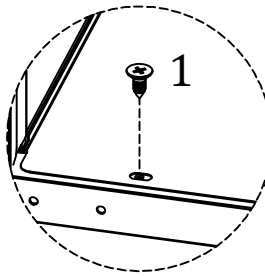
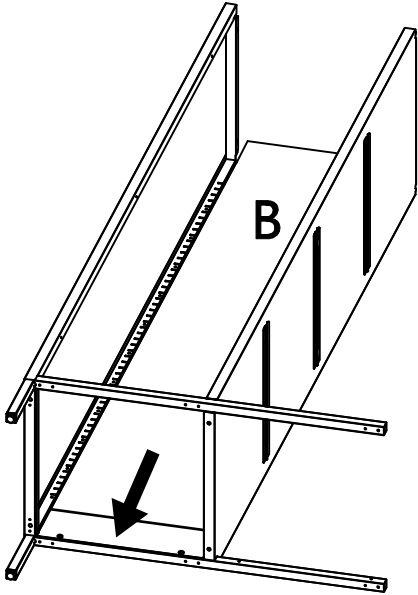
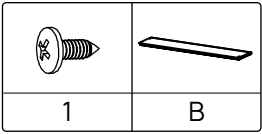

2.

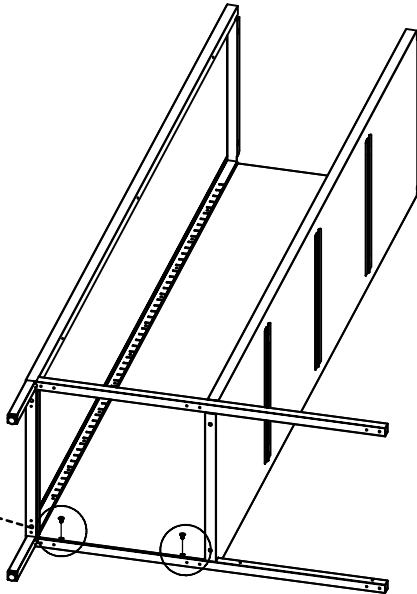

x2



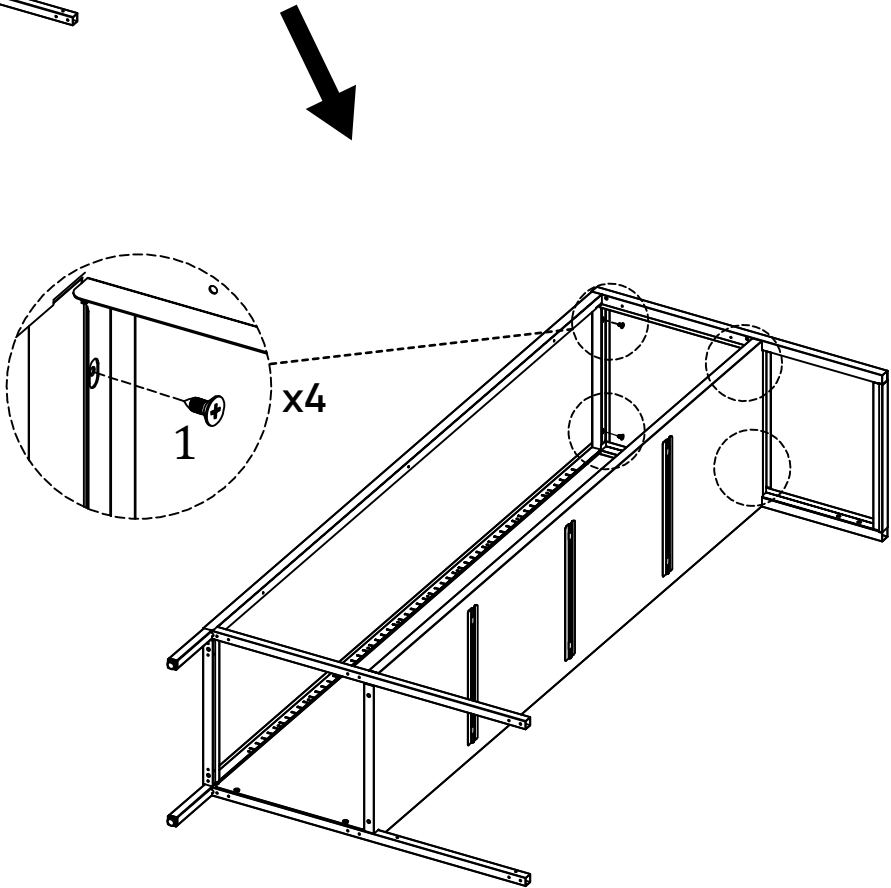
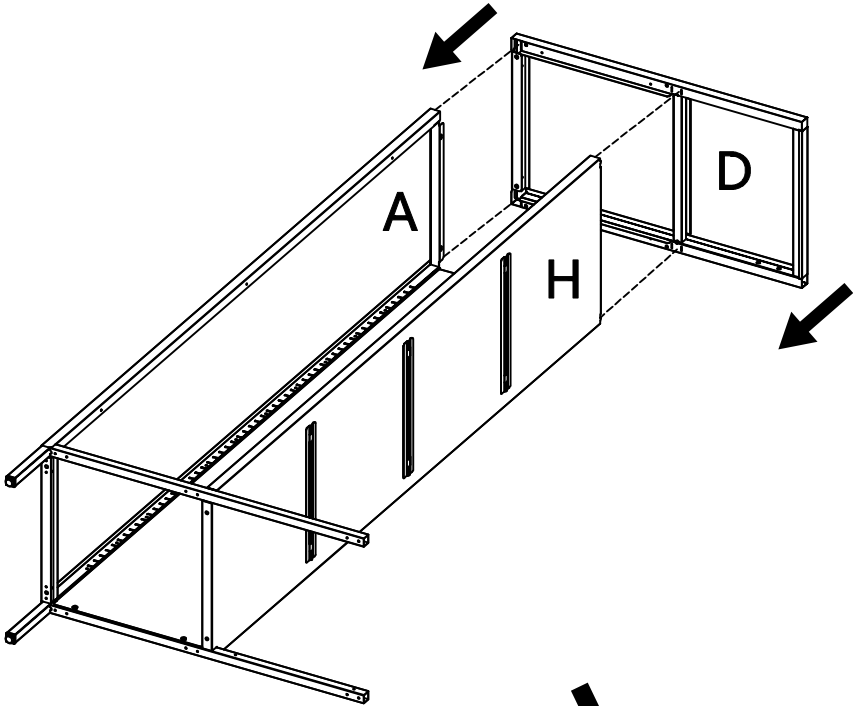

3.

	
1	D



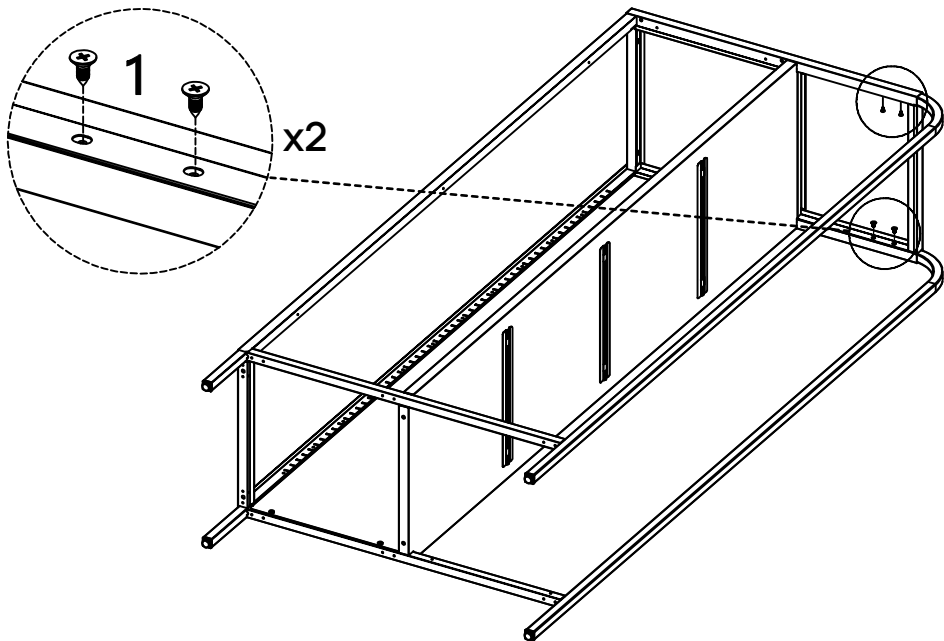
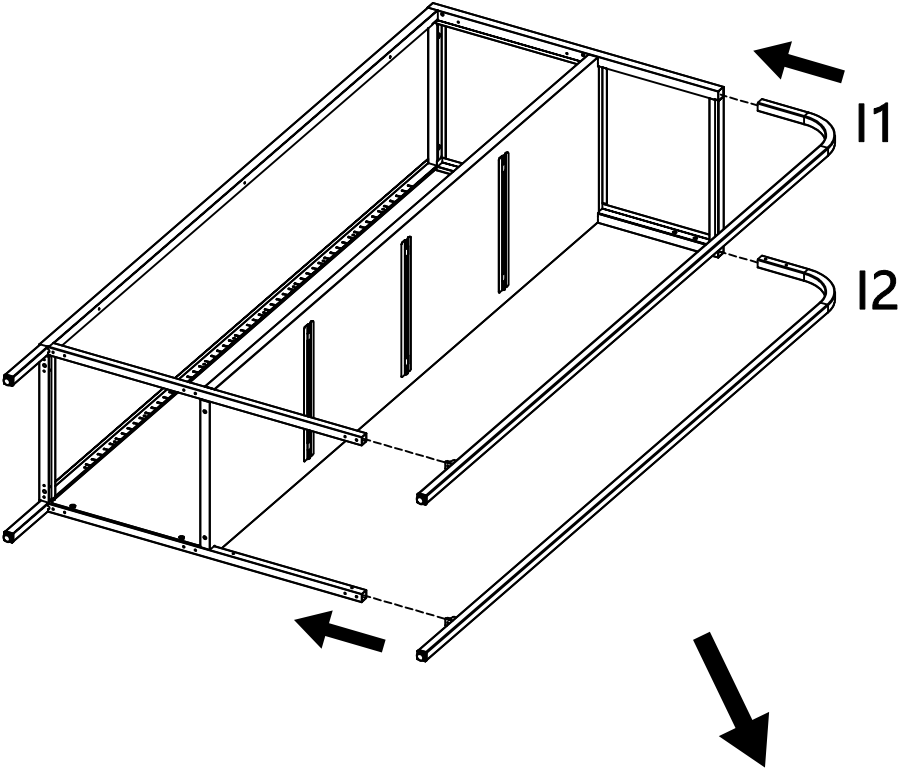

4.

		
1	I1	I2



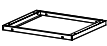

5.

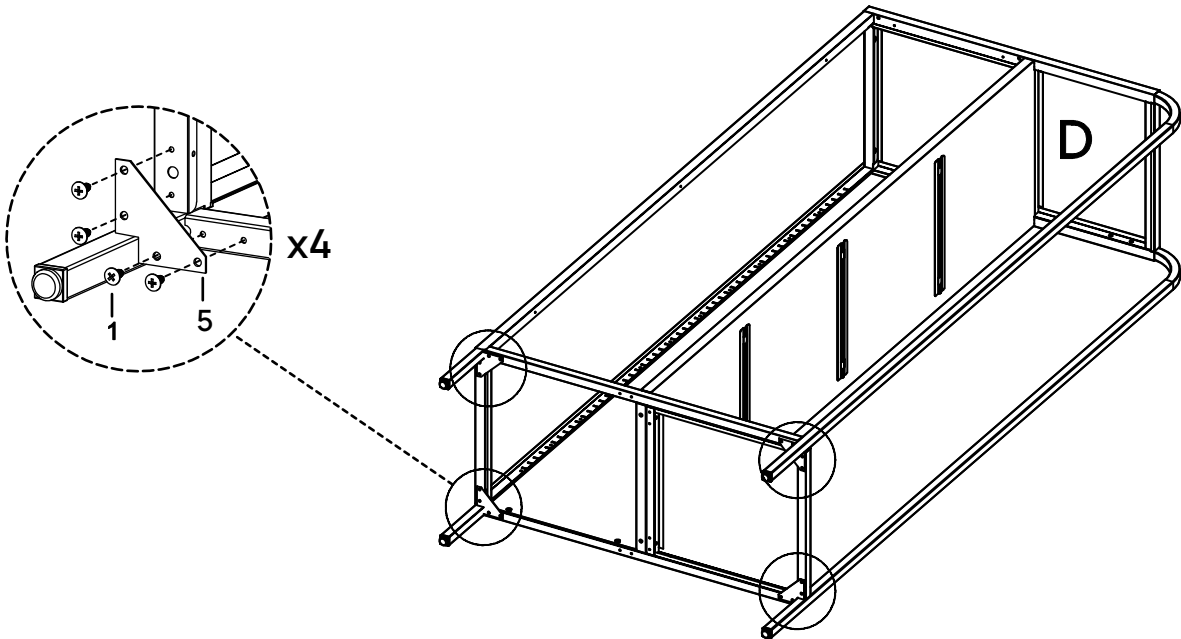
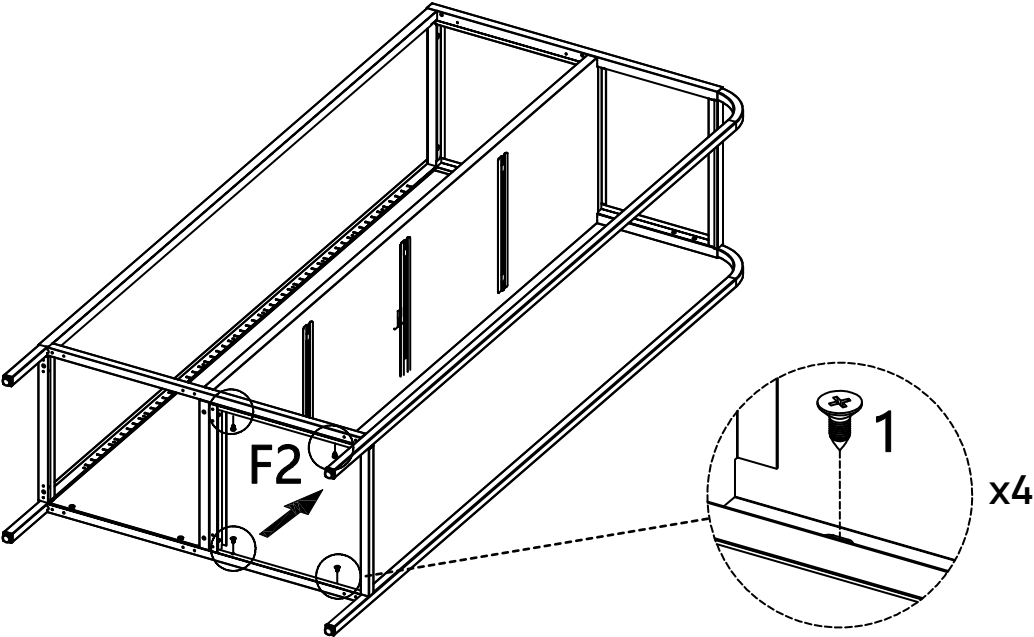
		
1	5	F2





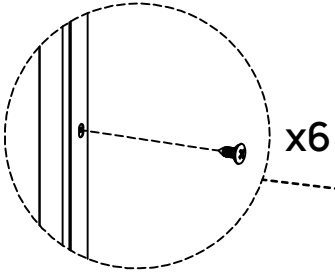
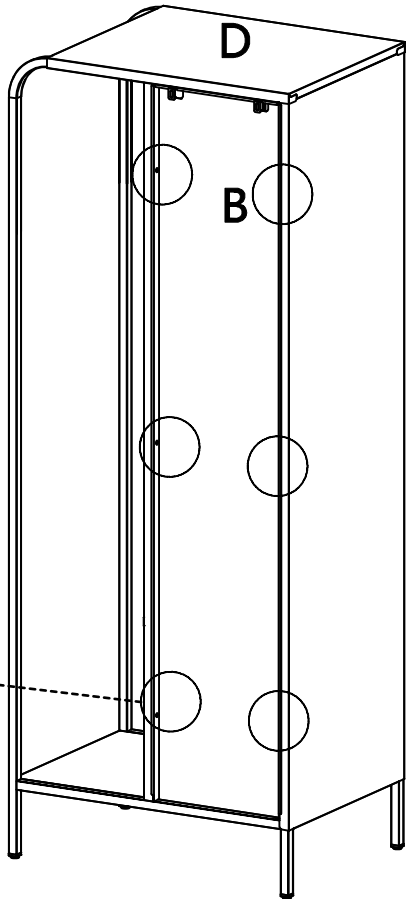
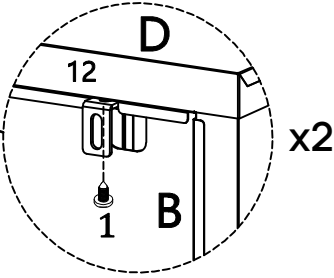
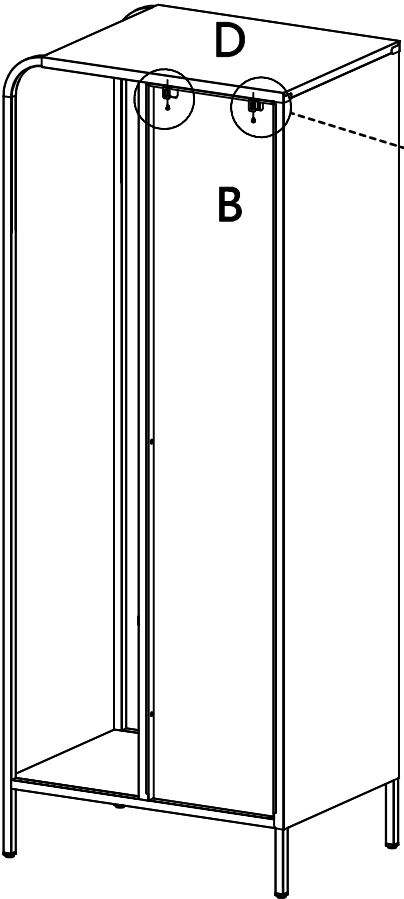

6.

	
1	12

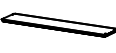

7.

			
1	7	B	F1

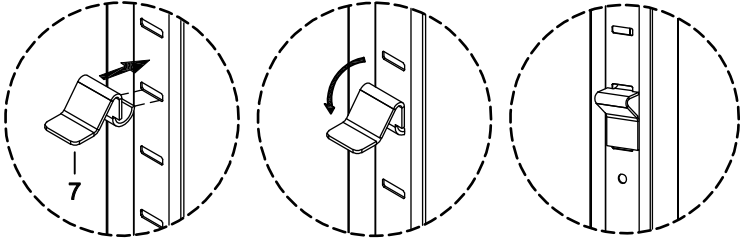
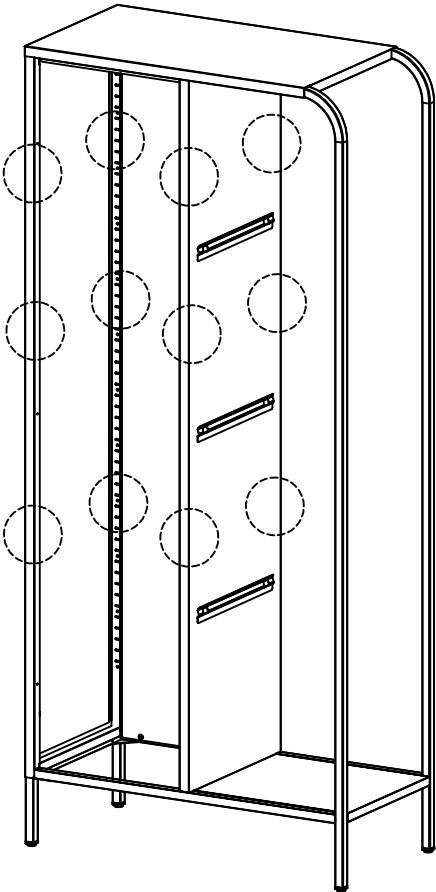

x12

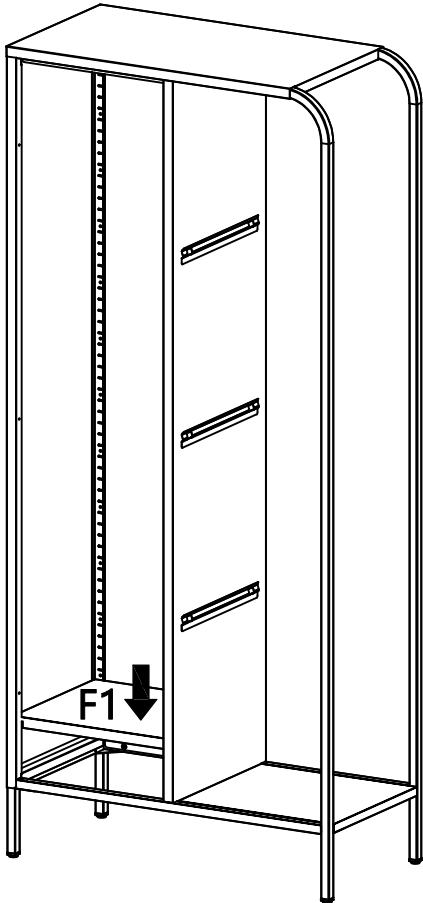



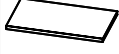
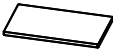

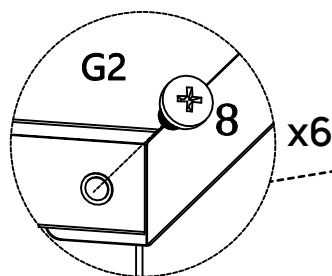
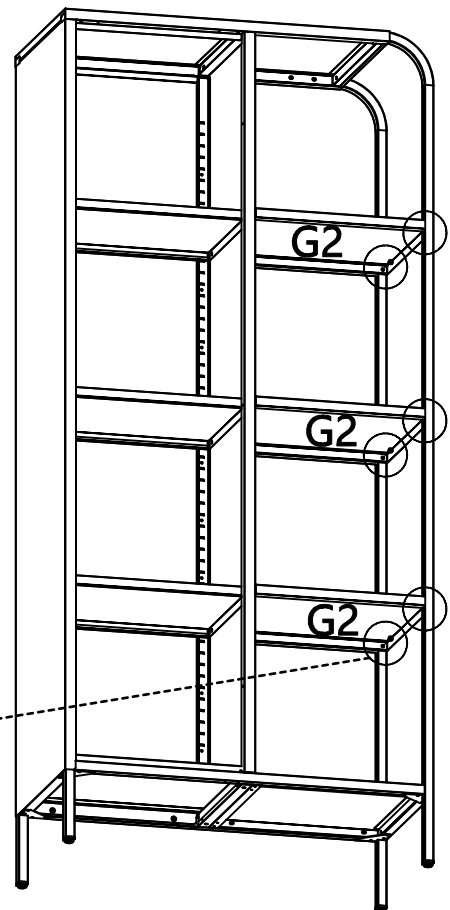
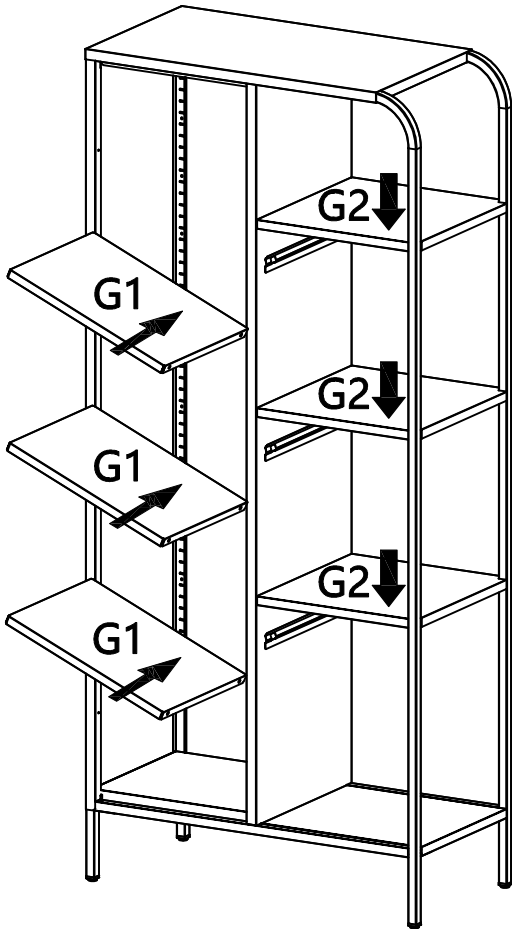
8.

		
8	G1	G2



9.

				
3	4	6	9	C

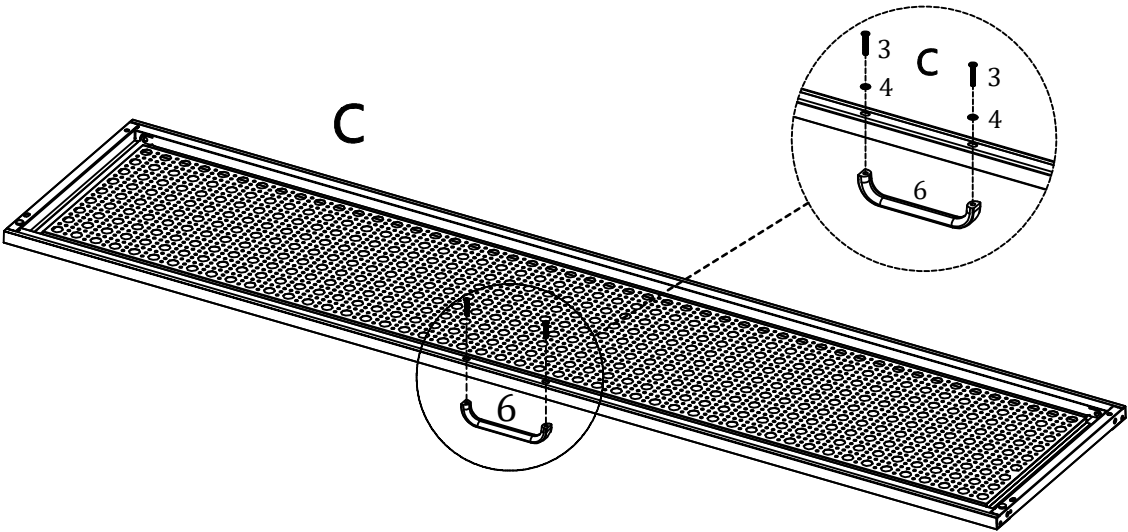
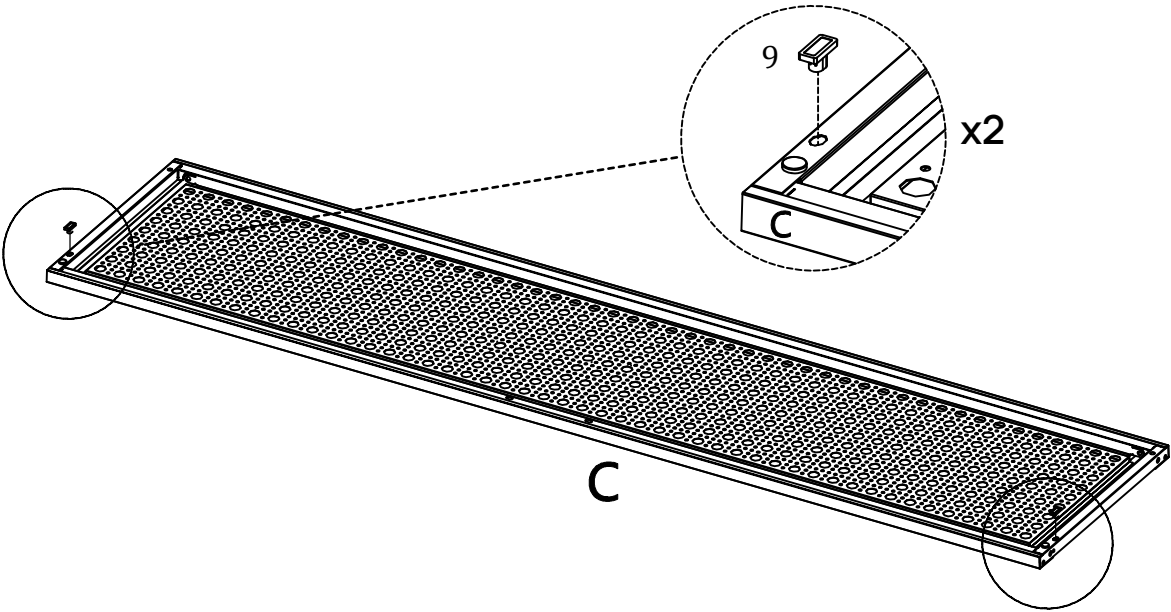

10.

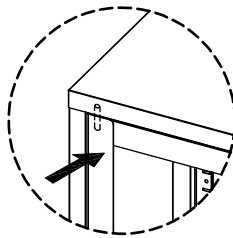
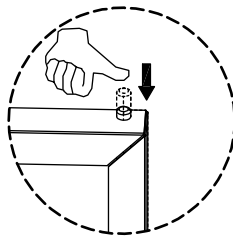
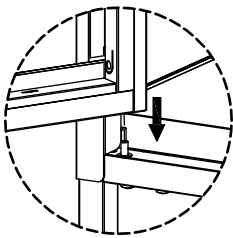
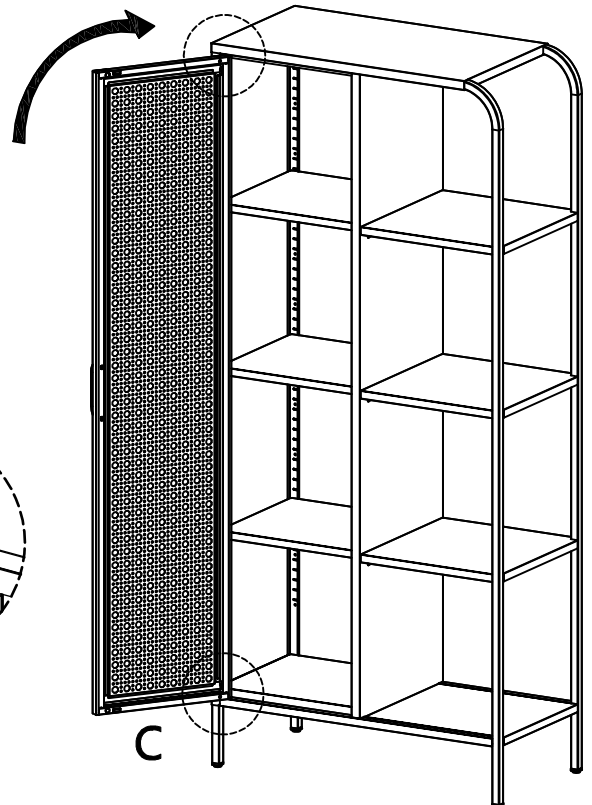
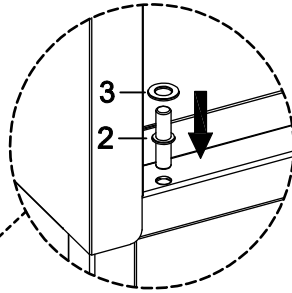
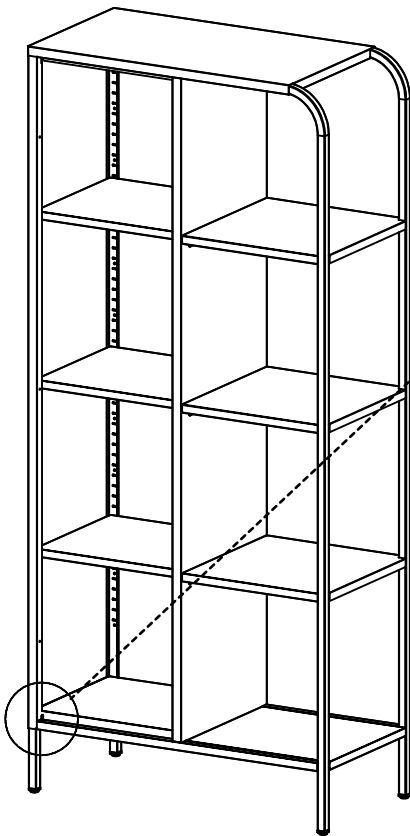
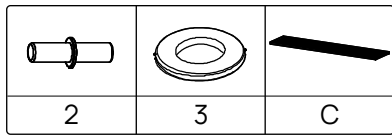

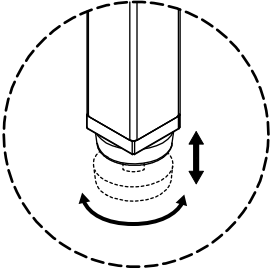
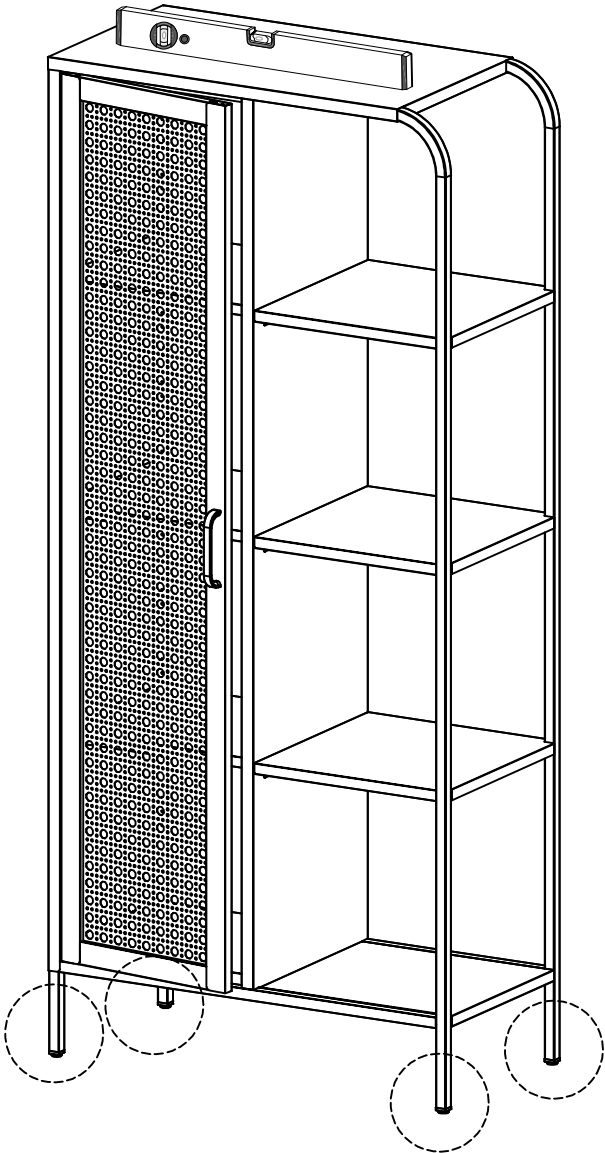

11.



x4

12.

	
10	11

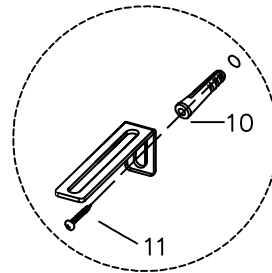
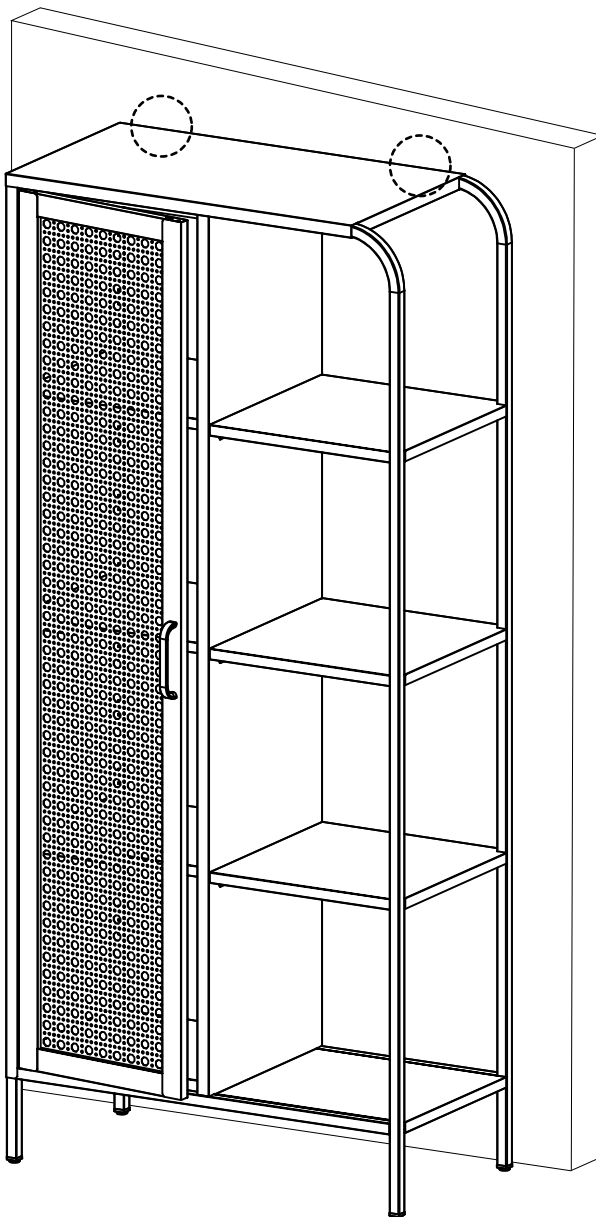
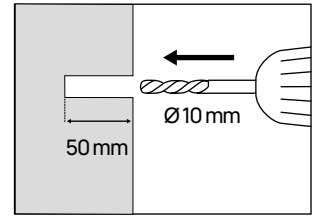
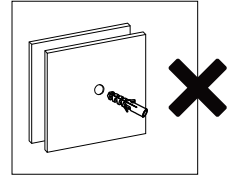
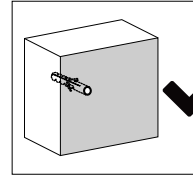

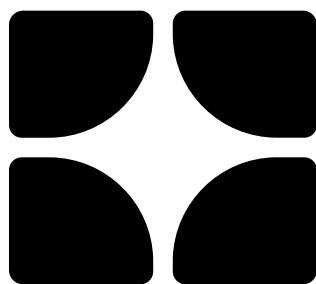

Montez, installez, détendez-vous !

SICAAN.