

# Siccan.

---

## JACQUES

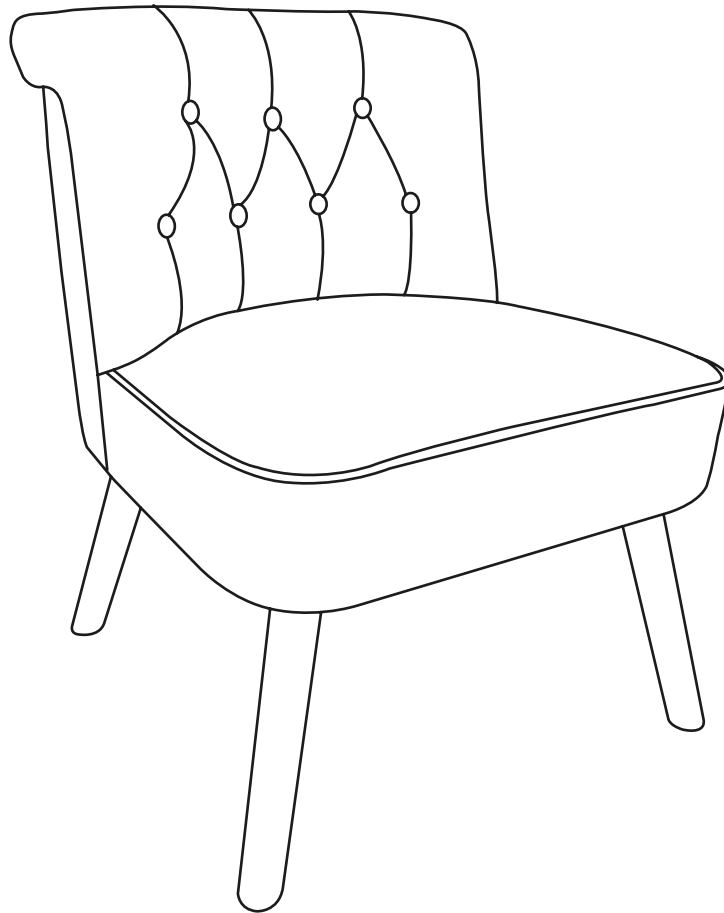

15 min



x1





CE

---

STI-000306 [x1]

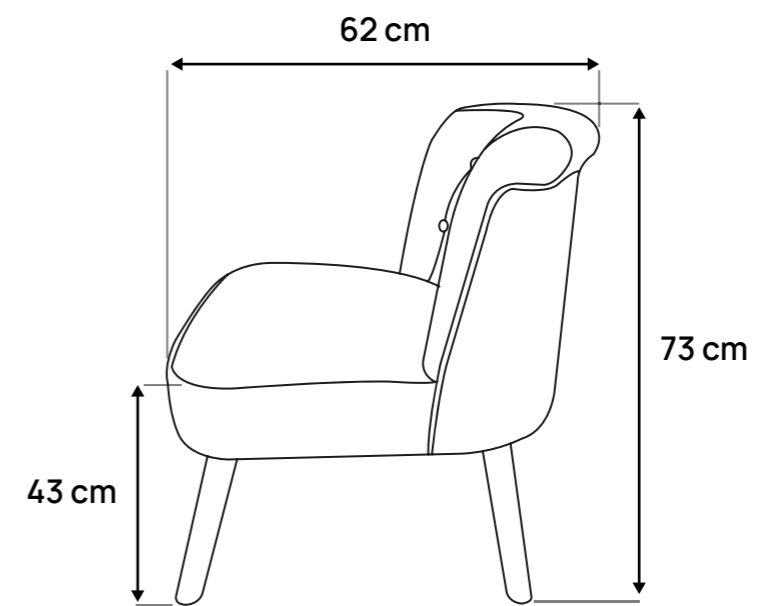
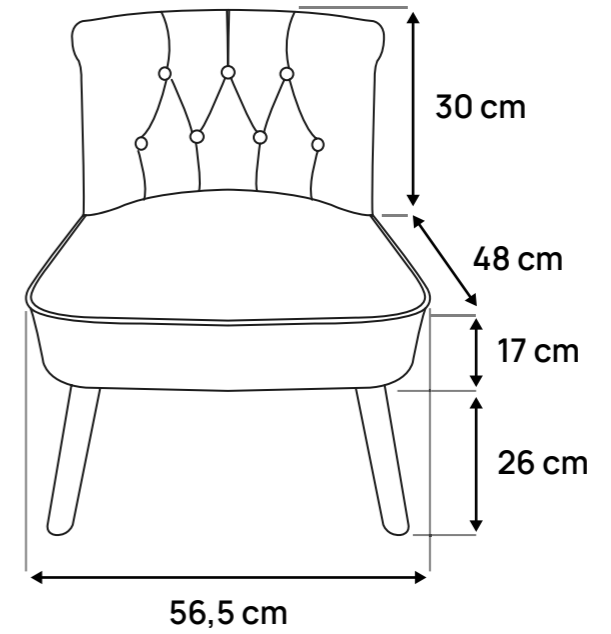
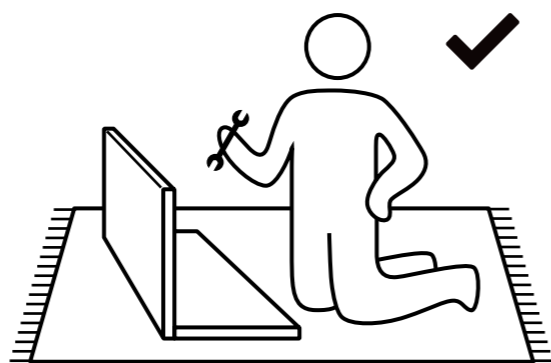
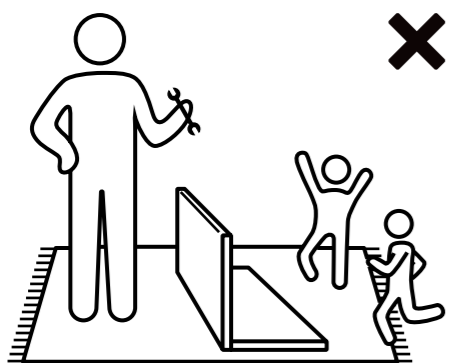
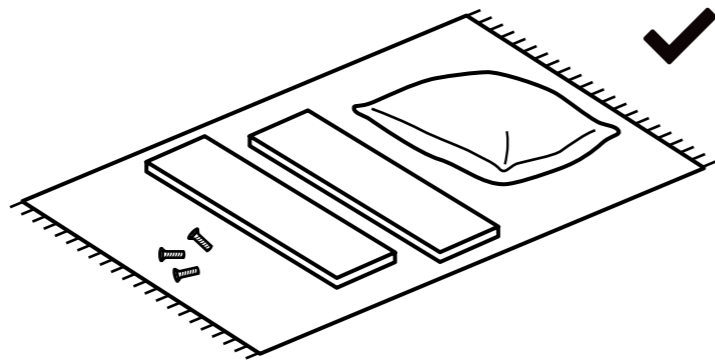
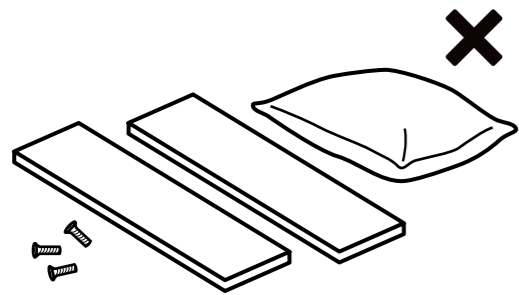
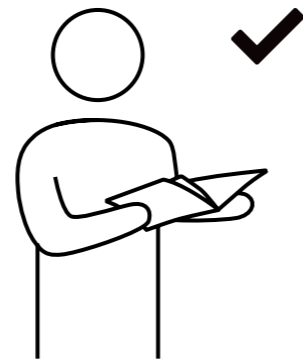
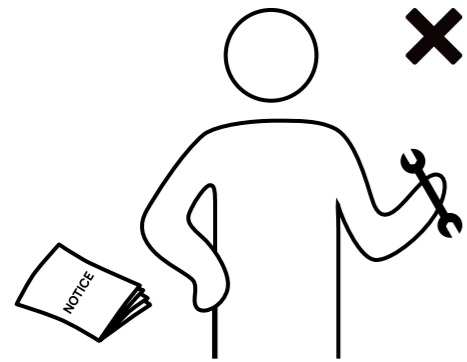
07/2024

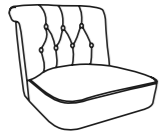
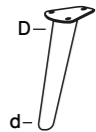

PCS	REF	QTY	DIM
	KR-105502	x1	56.5x62x47 cm
	KR-JM01	x4	$\varnothing = d = 3.8 \text{ cm}$ $D = 4.5 \text{ cm}$
	KR-M62001	x12	M6 x 20 mm
	KR-BS01	x1	M6

1.

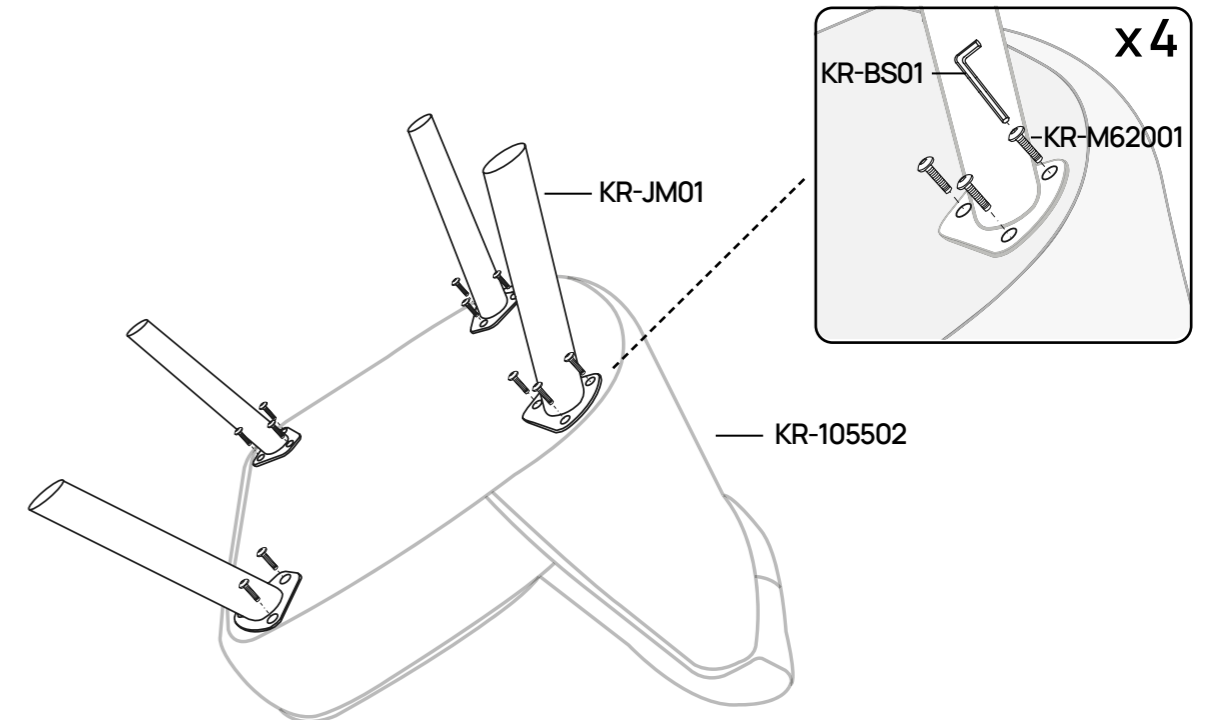
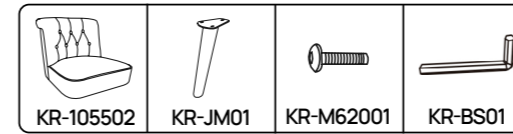

2.

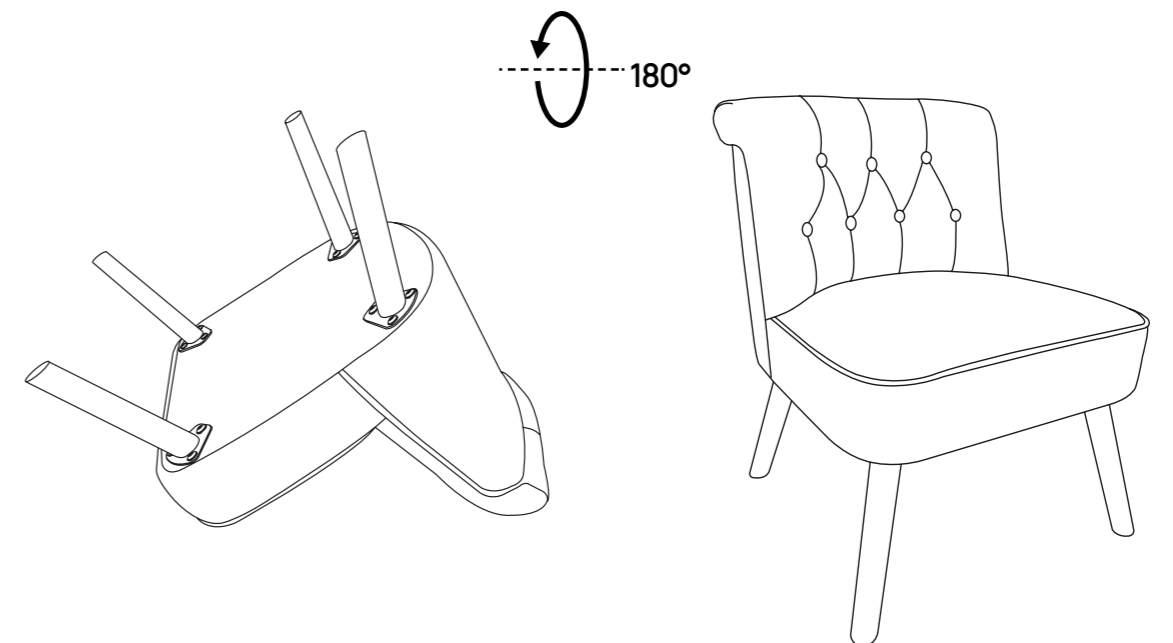

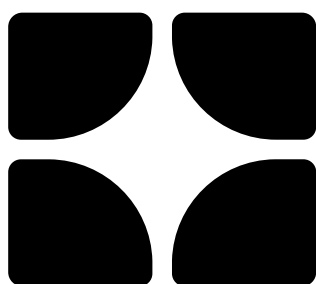

Montez, installez, détendez-vous !

**SICAan.**