

Sicdan.

STELLA

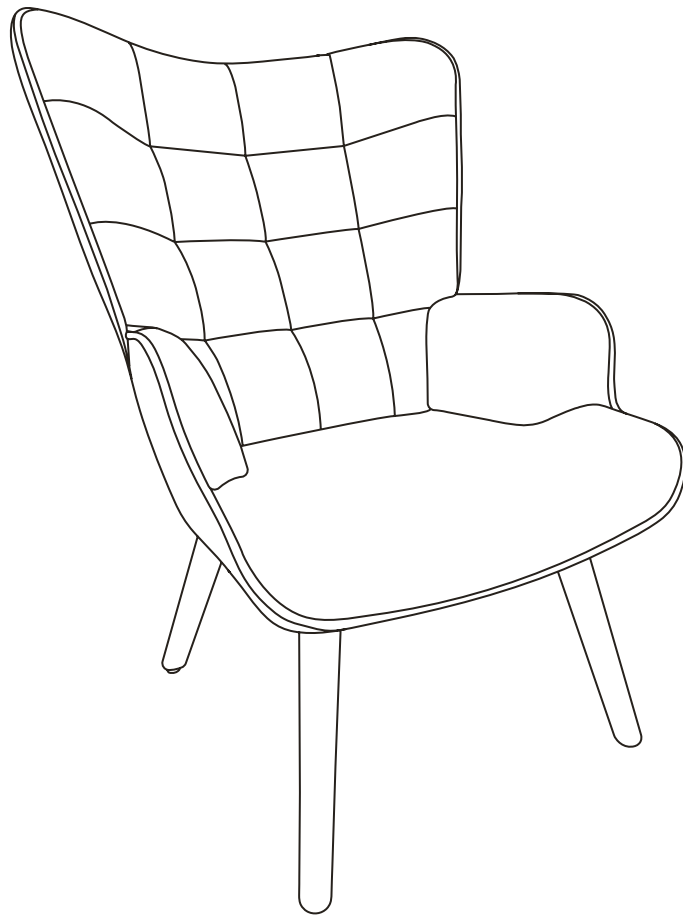

15 min



x1







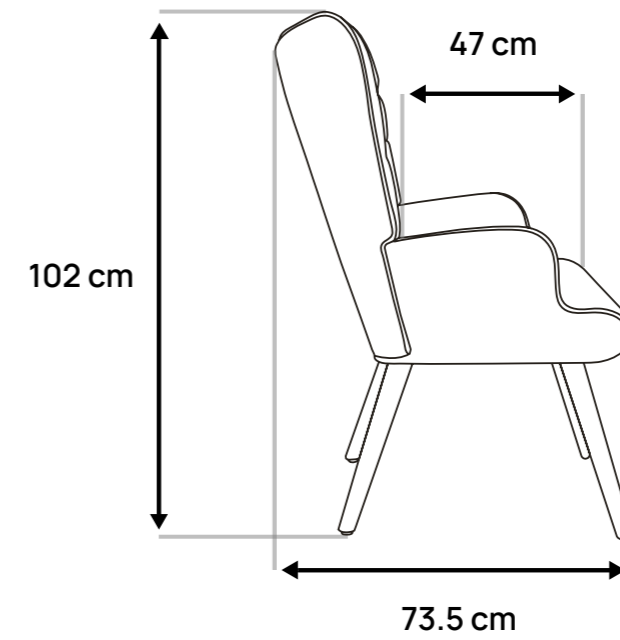
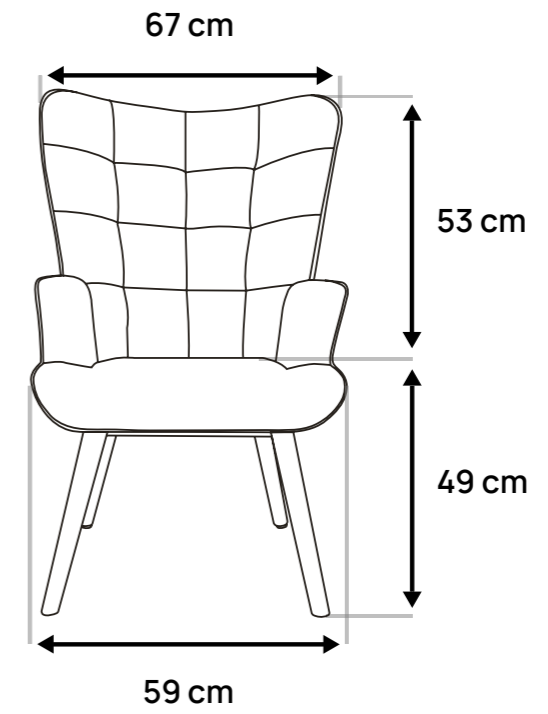
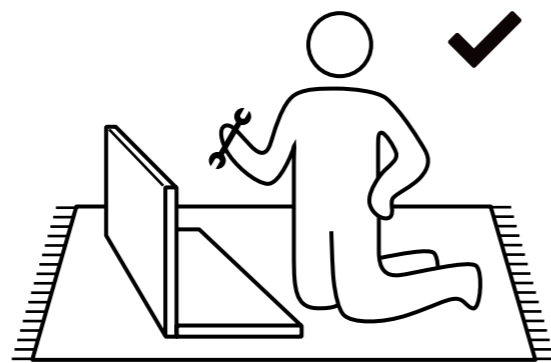
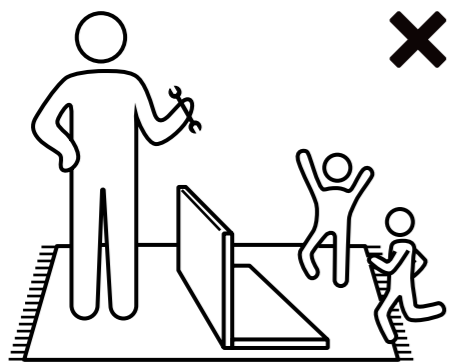
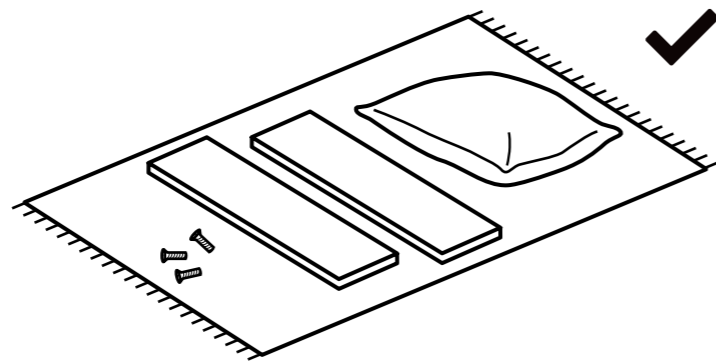
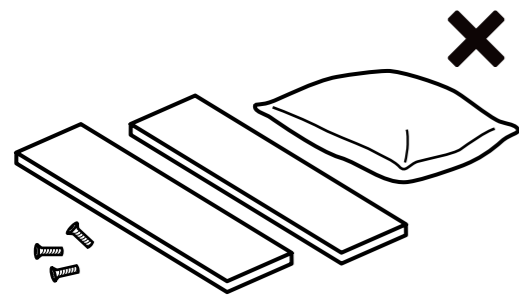
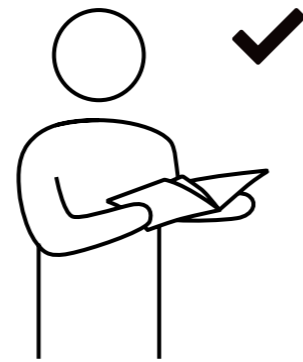
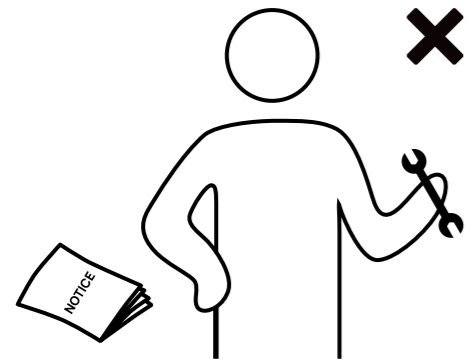

CE

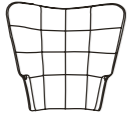
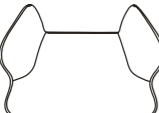
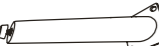
STI-000329 [x1]

07/2024

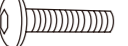

| PCS | REF | QTY | DIM |
|---|---------------|-----|------------|
|  | AN-BK001A-BG2 | x1 | 67 x 53 cm |
|  | AN-ST001B-BG2 | x1 | 47 x 59 cm |
|  | AN-SL001C | x2 | L= 34 cm |
|  | AN-SL001D | x2 | L= 36 cm |
|  | AN-SH001E | x2 | M6 x 40 mm |
|  | AN-SH001F | x2 | M8 |
|  | AN-SH001G | x16 | M6 x 18 mm |
|  | AN-SH001H | x1 | M6 |

1.

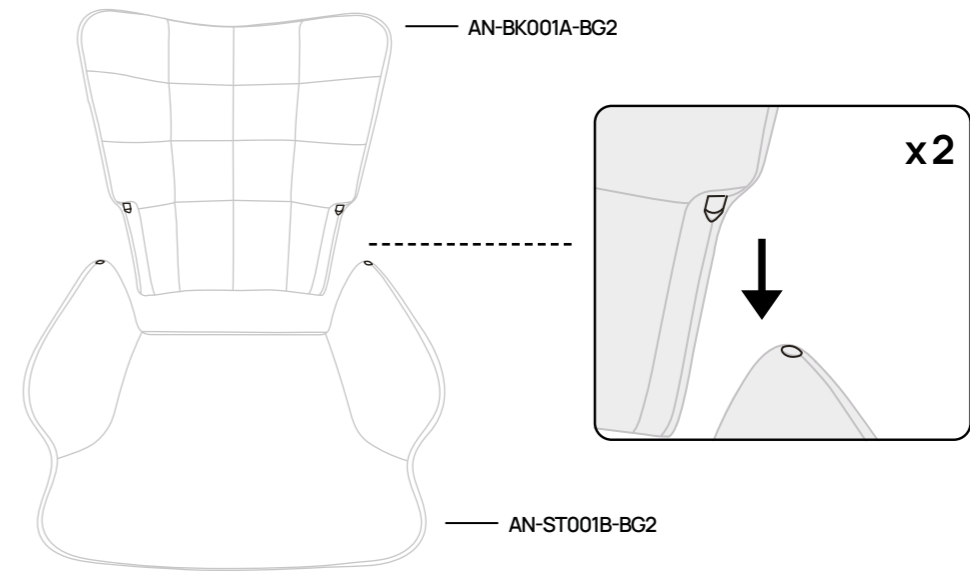
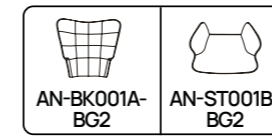

2.

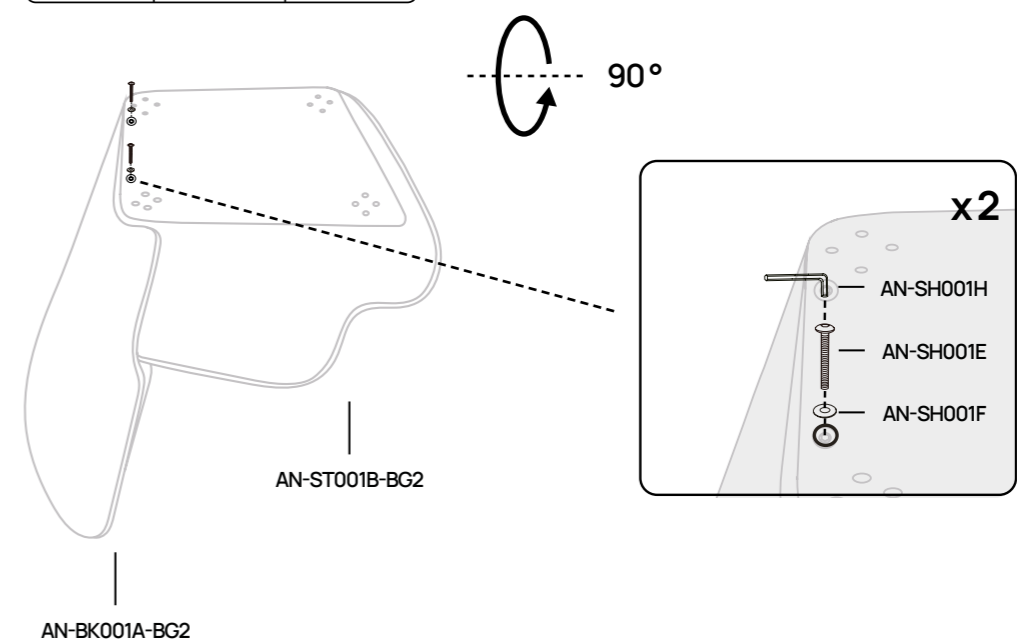
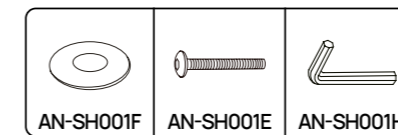

3.

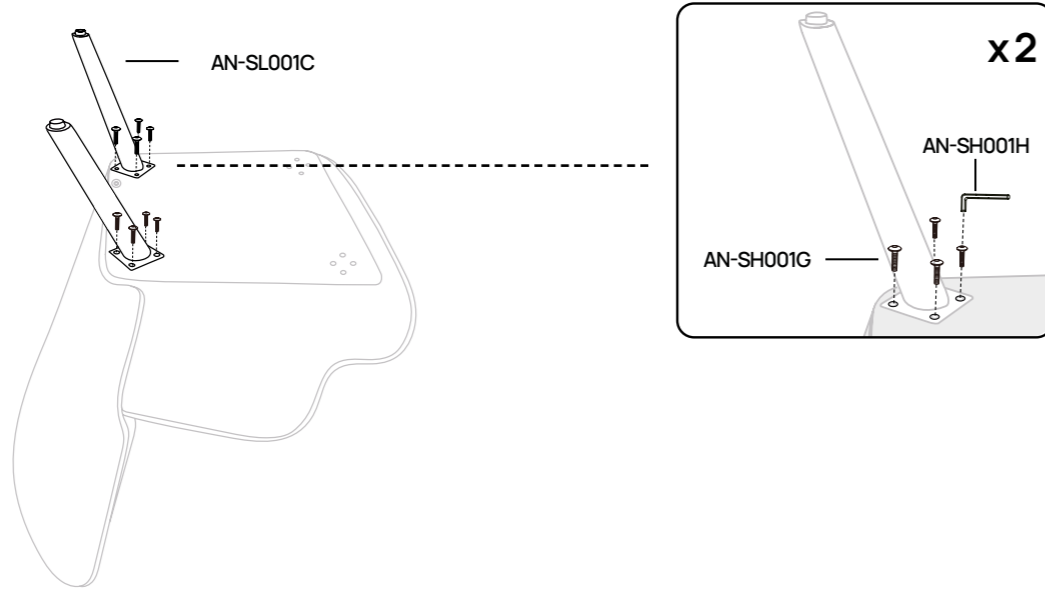
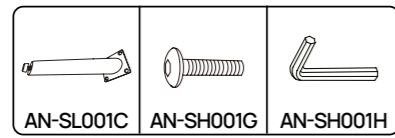

4.

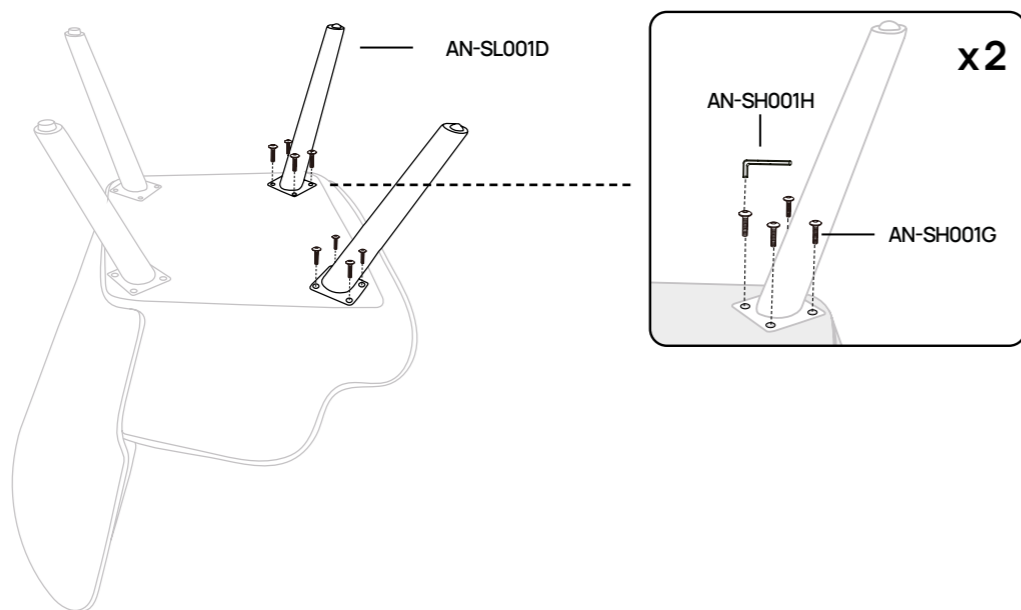
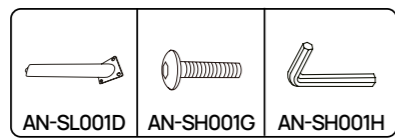

5.

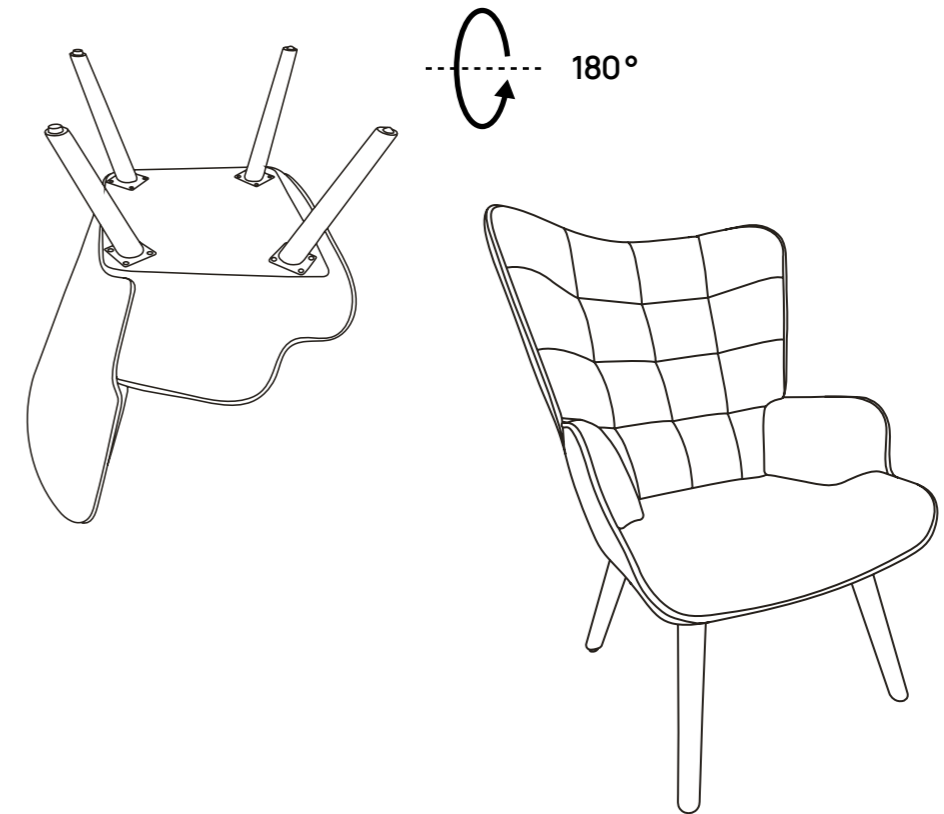

6.

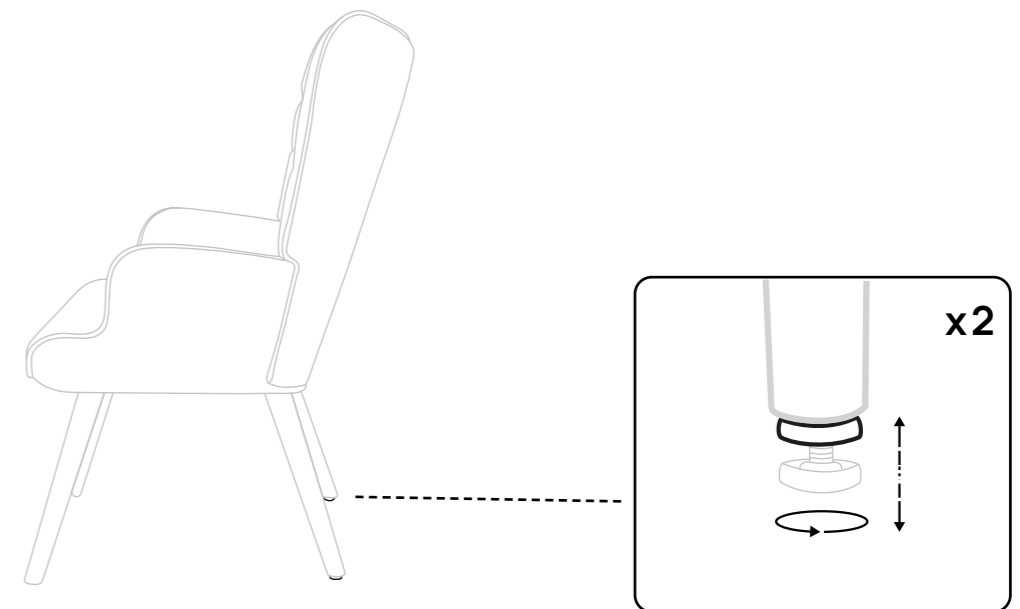

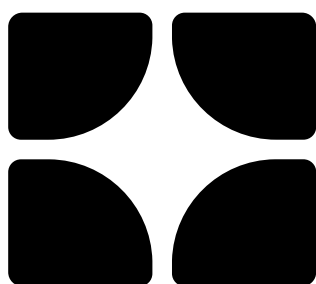

Montez, installez, détendez-vous !

SICAan.